

vLinn

ALY JAMES LAB

LM-1 DRUMS VST



USER MANUAL



WINDOWS 32BIT

vLinn

LM-1 DRUMS

www.alyjameslab.com

USER MANUAL 1.0

BY

Aly James



©2014-2015 ALYJAMESLAB

TABLE OF CONTENTS

INTRODUCTION.....	3
INSTALLATION.....	6
CONTROL PANELS	9
THE AM6070 DAC.....	11
SAMPLE TUNING.....	15
THE HIHAT CASE.....	18
MAIN PANEL.....	19
CEM FILTERS	19
SETTINGS.....	22
EPROM LOADING.....	24
PRESETS IMPORT / EXPORT.....	27
MIDI AUTOMATION.....	28
LM-1 SEQUENCER	29
HIDDEN SECRETS.....	31
LINKS.....	32
DISCLAIMER & LICENCE AGREEMENT	33

INTRODUCTION

My name is Aly James;

French steam funky musician, composer and creator of strange musical DIY devices and software.

I was planning for a long time to make an accurate Linn LM-1 VST dedicating to the 1st Sample Based Drum Machine in History, mainly because I have never been happy with packs of samples coming from different recording chains, lacks of control over the pitch and all that makes the unique funky sound of that legendary drum computer made by Roger Linn.

The Linn was **THE killer drum machine in town back in the 80's**; it was also the first that include real drum samples!

The Linn LM-1 Drum Computer was created by Roger Linn. He used samples of acoustic drum sounds recorded on the fly with some basic hardware he made at that time. The fact that they were recorded raw with a custom made ADC, ignoring the basis of digital recording makes them **cut better in a mix** than anything available at the time, they sounded so great that they become an alternative to the analog drum sounds of the 80's drum machines.. To this day the **unique sound of the LM-1** is highly regarded and only using samples of an LM-1 output cannot reproduce the wide range of sounds this machine can produce. **The DAC in use in here and the whole circuitry stands next to the samples characters in that unique sounding team.**

The LM-1 is an historical piece of gear that has a place in the sound of the 80's era.

Only around 500 of these things are out there so don't count on finding a working one easily or for cheap. It has been used by major acts like:

Prince, Phil Collins, Thompson Twins, Stevie Wonder, Gary Numan, Depeche Mode, The Human League, Jean-Michel Jarre, Vangelis, John Carpenter, Todd Rundgren, The Art of Noise etc... The Machine was made by a musician for musicians and I tried to stick to that standard. So as there were no accurate VST for that legend out there...

I had to make the VLINN!

Personally, I grow up listening a lot of Funk Music and especially the Minneapolis Funk scene, The LM-1, Linndrum & DMX Drum Machines sound were preeminent and were a huge part of that particular sound. The fact that the LM-1 had multiple outputs screamed for experimentation and it

wasn't uncommon to send each drum sounds to fx units or guitar pedals. The usage of algorithmic gated reverbs of that era was also part of the sound (think AMS RMX16 or Eventide harmonizer). Most of the rare LM-1 machines were usually modified to suit the artist needs, increasing pitch range, adding external triggers & changing stock EPROMS samples wasn't uncommon. Still, the characteristic stock sounds of the Bass, Snare, Claps, Rim shot and Hihat were always present.

The coolest thing was that each and every sounds of the LM-1 were tunable and as they were stored in EPROMS chips, they can be replaced by other EPROMS with different or custom made samples.

The Linn LM-1 was controlled by a Z80 processor and featured a built in sequencer. An urban legend goes on for a long time about the LM-1 having a special groove and even a kind of secret randomization built in...This is plain false, as Roger Linn himself have recently stated and debunk the myth, the LM-1 groove only comes from the low resolution of its sequencer, which is, 48PPQN (see LM-1 Sequencer section)

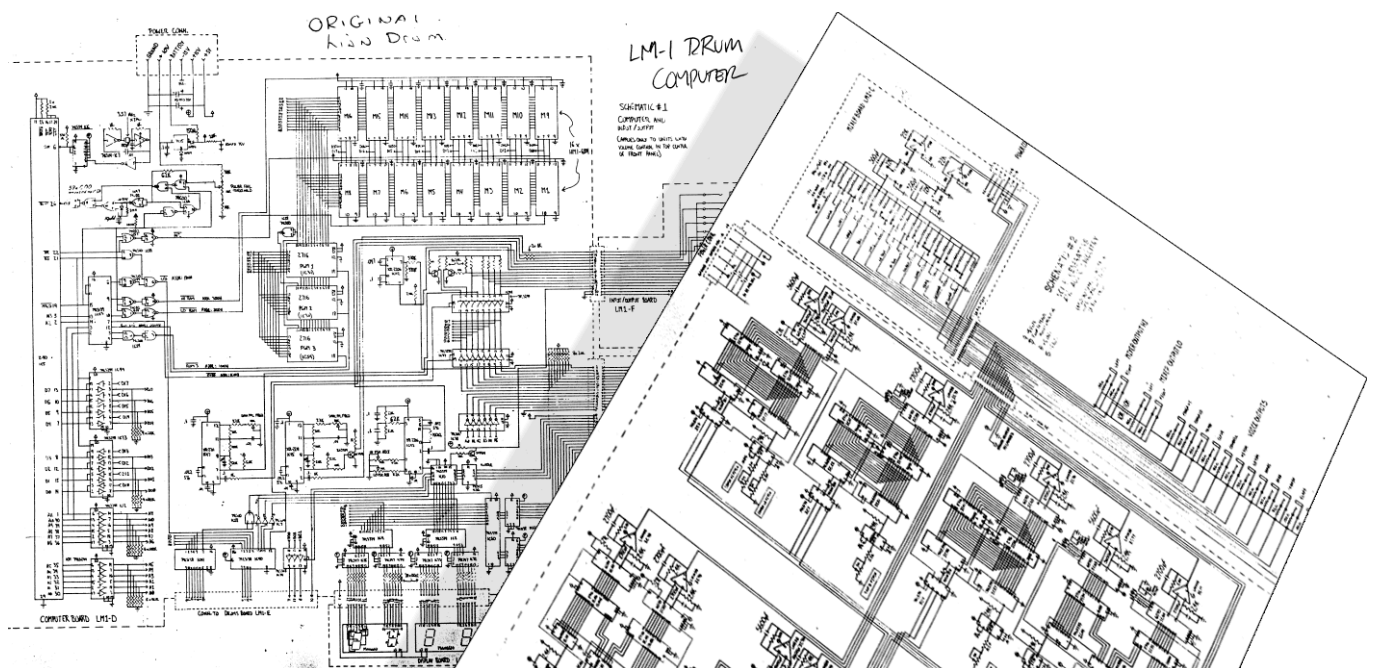

This emulation is based on reverse engineering and old datasheets; it uses a C++ custom core with modeled AM6070 DAC, Oscillators, counters, OPAMPS & Filters.

The product has been assembled through the SYNTHEDIT framework using the very last version, Mostly custom C++ coding and some third party licensed code where nothing fancy were needed. It will be ported to OSX at some point in the future.

Thanks to all the nice people that started to use VLINN and support my projects and to proud owners of original Linn LM-1 Units who have sent me some recordings to make tests.

A special thanks to Roger Linn (LM-1 Creator) & Paul J Whites (Electrongate.com).

Full Credits & Thanks can be accessed on the VLINN GUI panel.

Mainly,

VLINN can be triggered via MIDI following mostly the GM MIDI Drums mapping.

Each trigger will engage a binary counter that will run at the speed of an oscillator which pitches is fixed by the tune knob setting. Byte after byte, the EPROM content will be read and the output will be decoded by the emulated AM6070 DAC. The output of the DAC is amplified by an OPAMP and will be filtered in some way differently depending on the voice. The counter will read all the EPROM content even if you release the key before the end.

A main mixer is used to set the volume of each voice before it hits the output stage. The Linn LM-1 featured panning switches that are not needed anymore because we have separate outputs that will be mixed and panned inside a DAW; hence there is no panning in VLINN VST.

Each voice has its own tune knob that will control the speed of the EPROM data reading, the range available is 978 Hz – 44092 Hz which correspond to a real mod you can apply to the Linn LM-1 to increase the pitch range, stock was 12048 Hz – 30303 Hz). (See Sample Tuning.)

Seven of the stock LM-1 EPROMS can be replaced by external compatible content and an additional voice can also be used. This opens up to Linndrum sounds (often called LM-2), DMX, Drumtracks etc... and even your own created EPROM content (See EPROM Loading.)

Basic MIDI implementation:

MIDI IN:

VLINN can receive any MIDI CH as main source for triggers.

It can be triggered with a standard MIDI Keyboard/Pads or even a MIDI Drum Kit.

The mapping follows almost the same mapping as GM MIDI Standard.

Note that most DAW can convert incoming MIDI notes to another if needed and that most of the hardware MIDI pads can be assigned to any MIDI notes.

Bass – MIDI notes 35, 36	Conga High – MIDI note 49
Snare – MIDI notes 38, 40	Conga Low – MIDI note 50
Hihat Closed – MIDI notes 42, 44	Claps – MIDI note 39
Hihat Open – MIDI note 46	RimShot – MIDI note 37
Cowbell – MIDI note 56	Tambourine – MIDI note 54
Tom High – MIDI notes 41, 43, 45	Cabasa – MIDI note 51
Tom Low – MIDI notes 47, 48	Additional Custom Voice – MIDI note ??

INSTALLATION

COMPATIBILITY

VLINN is a Windows 32Bit VST Instrument for use with MIDI capable DAWs.

RUN on 32/64 Bit Systems.

If you want to use it with a 64bit DAW you can use JBridge or internal DAW Bridge.

INSTALL VST

1. Decompress the downloaded archive file
2. Copy the entire Folder **VLINN** to your VST PLUGINS folder
3. Load it in your DAW

INSTALL STANDALONE

1. Decompress the downloaded archive file
2. Copy the entire Folder **VLINN_STANDALONE** where you want
3. Simply RUN **VLINN.exe**

State of VLINN current features

WIN 32 VST runs on 32/64Bit Systems and it is multicore compatible.

HIGH QUALITY GUI

(Different panels for controls etc...)

INSTANT UPDATE FOR ALL CONTROLS

FULL MIDI AUTOMATION

With midi learn (right click to assign MIDI)

AM6070 MODELED REAL TIME DAC DECODING

Following the exact datasheet decode table for 8bit companded incoming DATA.

HIHAT DATA LOOPING & VCA

The LM-1 Hihat circuitry was pretty unique, the hihat proms were read constantly in a loop while only a VCA was triggered, for closed hihat the circuitry had the ability to discharge the current through an additional way based on the decay pot setting. This basically makes the hihat sounding different on every hit.

CEM 3320 Filters

Unlike the very first produced LM-1, some Voices with Bass frequency content were filtered to minimize the remaining 8bit noise, using a VCF configured as a 4 poles low pass filter with no resonance. The CV frequency of the VCF was shaped by the circuitry in a way that lets the transients pass through relatively unfiltered. The VLINN lets you fine tune the CV pulse or completely bypass the filter, this is useful when a voice is tuned very low or if you want to replace a "Bass" slot with another EPROM that doesn't require filtering.

SEPARATE PITCH TUNING

This is one of the coolest features of the LM-1, letting you tune any voice to a particular frequency for a wide range of sounds.

The PROMS data were read one byte at the time by a counter which speed was controlled by a relatively stable oscillator, the counter reading speed could then be affected by the external tuning pots in a limited range, + or - 1 Octave.

This tuning range can be tweaked and the VLINN provides a useful wide range of pitch from 1000 Hz to 44100 Hz and anything in between.

(Stock setting range was 12048 – 30303 Hz. See Sample Tuning.)

SEPARATE OUTPUTS

The LM-1 features separate outputs for every voices, so as the VLINN.

You can choose from ALL to 1 Stereo Channel or Separate Stereo Channels for each voice.

VELOCITY CONTROL

You can limit yourself to only 2 velocity levels or use the full range of MIDI velocity for convenience.

GUI & AUTOMATION

The GUI features the original trigger buttons for kick listening and controls over every aspect of the Drum Machine, most of the parameters like volume and pitch knobs can be MIDI learned and controlled by an external MIDI Hardware.

LOADING EXTERNAL EPROMS DATA

The VLINN provides the ability to replace some voices with external compatible 8bit companded EPROM data, which opens up the machine to LINNDRUM (LM-2) samples, LINN 9000, DMX, DX, DRUMTRACKS etc... Even load your own custom made. You can switch between custom loaded and stock EPROMS on the fly.

VLINN supports the following type and size EPROMS binaries (.bin)

2716(2048_Bytes) 2K

2732(4096_Bytes) 4K

2764(8192_Bytes) 8K

27128(16384_Bytes) 16K

27256(32768_Bytes) 32K

LOAD & SAVE FULL PATCH & BANKS in FXB/FXP

CONTROL PANELS

Overview

VLINN GUI INTERFACE is pretty straight forward; it stores the different parameters on different panels.

The main sliders on the mixer **set the volume** for each voice.

The **Tuning** knobs set **the pitch (sample rate)** for each voice; you can also type in the precise pitch in Hz manually by clicking on the number itself.

The Hihat horizontal slider to the left bottom of the GUI **sets the decay value for the closed hihat circuitry**.

You can also trigger a voice by clicking on the corresponding drum pad, some of them have two velocity values available some not, and hence the double pads on Bass, Snare, Hihat, Tamb & Cabasa. Toms & Congas pads trigger either the high or low voice.

Note that the high Tom or Conga can be tuned lower than the low corresponding voice; this is basically just a name to differentiate the two voices.

Once a voice is triggered a red LED indicates the status.

These are the main panels than can be reached by the panel buttons to the left:

PANELS:

MAIN: Access to the Mixer Board.

CEMS: Access to the filters settings of the CEM 3320 chip for BASS, TOMS & CONGAS voices.

PROM Access to the EPROMS configuration panel.

SETS Access to settings like velocity handling and voice output routing, also displays the binary counters for each EPROM in real-time.

One is blank for future updates and extended features...



Hihat Decay



Right click on a knob, button or slider will open a midi learn assign menu. Ctrl click + move allow fine tuning.

THE AM6070 DAC

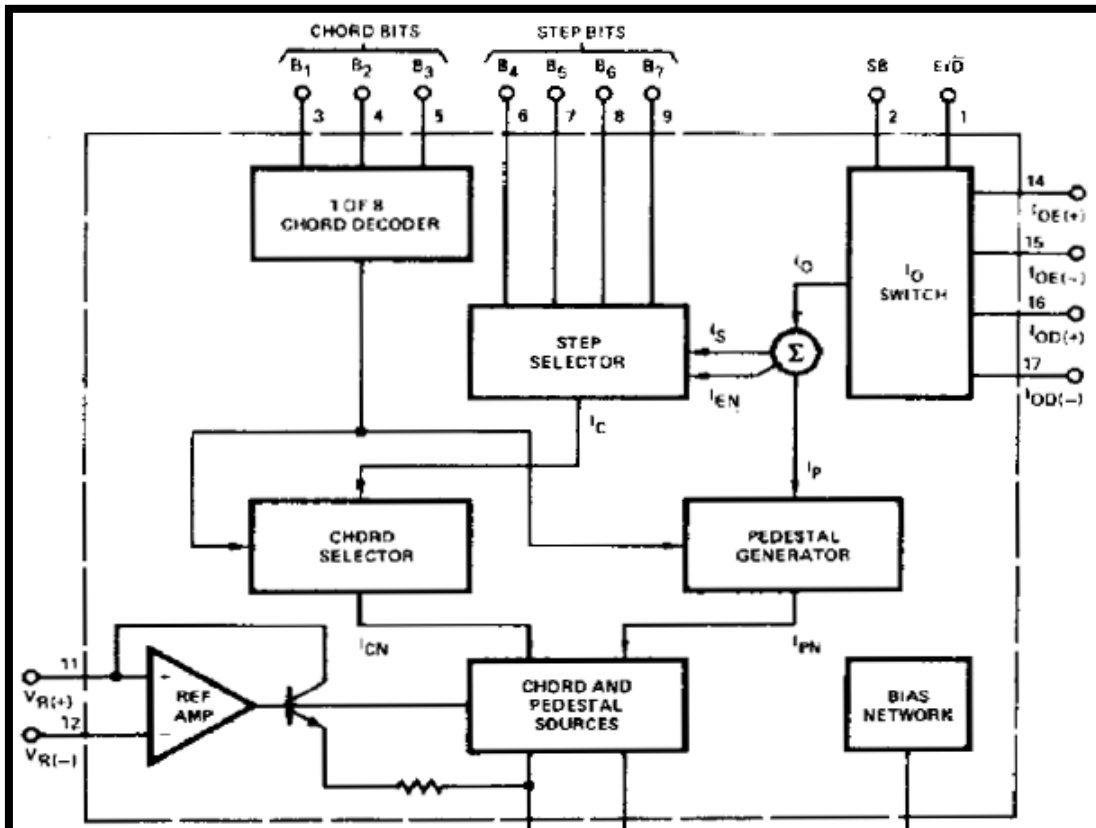
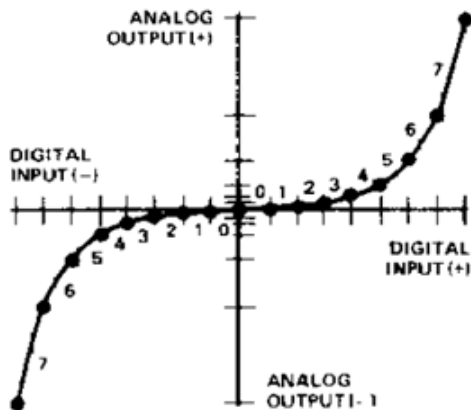

Table 6
Decoder Chord Size Summary

Chord	Chord Endpoints Normalized to Full Scale	Chord Endpoints in μA with 2007.75 μA FS	Chord Endpoints as a % of Full Scale	Chord Endpoints in dB Down from Full Scale
0	30	7.5	0.37%	-48.55
1	93	23.25	1.16%	-38.73
2	219	54.75	2.73%	-31.29
3	471	117.75	5.86%	-24.63
4	975	243.75	12.1%	-18.32
5	1983	495.75	24.7%	-12.15
6	3999	999.75	49.8%	-6.06
7	8031	2007.75	100%	0



The **AM6070 DAC** which is used for decoding every LM-1 voices to a linear voltage provides a 15-segment linear approximation to the Bell System μ -255 companding law. The law is implemented by using three bits to select one of eight binarily-related chords (or segments) and four bits to select one of sixteen linearly-related steps within each chord. A sign bit determines signal polarity and an encode/decode input determines the mode of operation.

It was a popular choice for 80s Pro-Audio gear. The **companding law gave the 8-bit sounds 12-bit performance**.

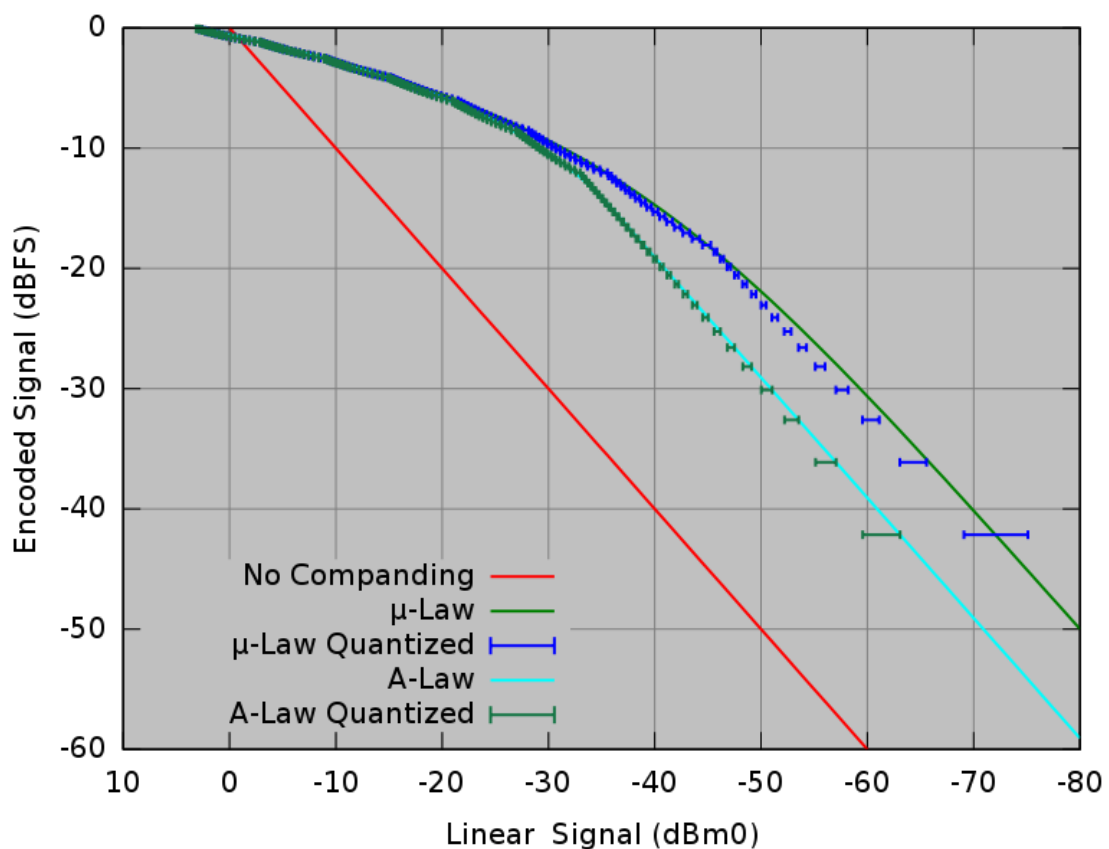

At that time, memory was pretty expensive and storing digital data in a tiny space was the way to go. The LM-1 samples were stored **in μ -255 companded format** in 8-bit, this is the main task of the AM6070 to turn this digital encoded data into an **analog voltage byte after byte**.

If you try to import a raw binary EPROM image in for example an audio editor like Audacity you will end up with a bunch of noise because companded format is not linear, it needs to be decoded first.

Basically, the DAC holds a constant value until the next sample comes in. To be theoretically proper, the extra higher frequency stuff is supposed to be removed by a reconstruction filter, resulting in a smooth signal and correctly reproduced spectrum. But vintage digital hardware don't do this (or badly), which **instead results in a bright, gritty sound**.

Modern sample playback techniques, which use phase accumulators and high quality interpolation, do a pretty good job of producing the "correct" signal, **but this doesn't have a gritty vintage sound because the image frequencies aren't there**. The result is that low resolution samples just sound dull.

This is particularly the case on the LM-1 when you lower the sample pitch; if you import a sample of a Linn LM-1 in a modern software or sampler and try to pitch it down, it will not sound the same and, depending on the interpolation method, will sound really less bright and nasty.

Keeping the same gritty 8-bit sound at any pitch was very important for VLINN VST to produce an accurate output.

Here is a comparison between a down-pitched LM-1 Claps sample at 13000 Hz in a modern audio editor VS a 13000 Hz tuned claps in VLINN VST, among the differences, one is clearly visible, one really lacks high frequency content.

The graphic ranges from 0Hz to 22050Hz.

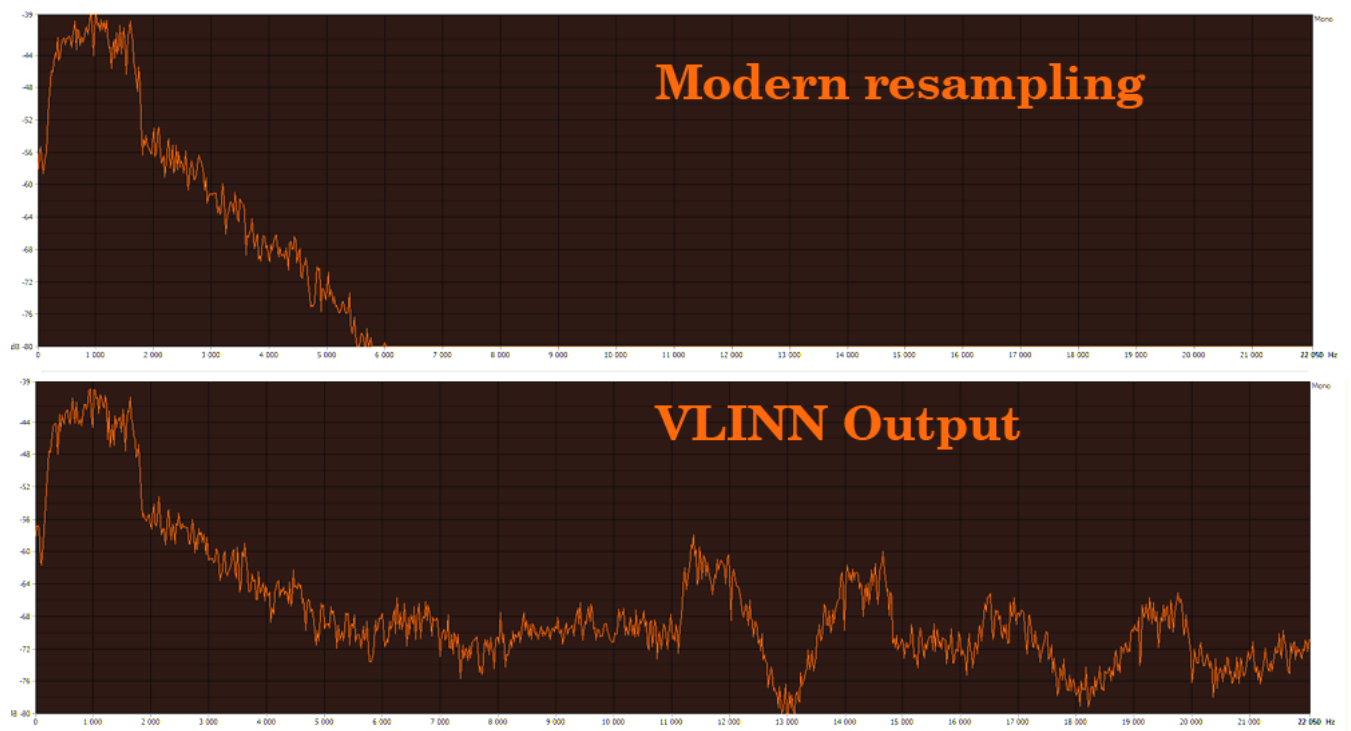

In VLINN VST like on the hardware, this process happens in real time as byte are coming to the DAC at the emulated XR2206 (Oscillator Clock) speed.

The exact decoder output table from the AM6070 Datasheet has been use in the VLINN Code for accuracy.

Am6070

ADDITIONAL DECODE OUTPUT CURRENT TABLES

Table 3
Normalized Decoder Output (Sign Bit Excluded)

Step (S)	Chord (C)	0	1	2	3	4	5	6	7
		000	001	010	011	100	101	110	111
0	0000	0	33	99	231	495	1023	2079	4191
1	0001	2	37	107	247	527	1087	2207	4447
2	0010	4	41	115	263	559	1151	2335	4703
3	0011	6	45	123	279	591	1215	2463	4959
4	0100	8	49	131	295	623	1279	2591	5215
5	0101	10	53	139	311	655	1343	2719	5471
6	0110	12	57	147	327	687	1407	2847	5727
7	0111	14	61	155	343	719	1471	2975	5983
8	1000	16	65	163	359	751	1535	3103	6239
9	1001	18	69	171	375	783	1599	3231	6495
10	1010	20	73	179	391	815	1663	3359	6751
11	1011	22	77	187	407	847	1727	3487	7007
12	1100	24	81	195	423	879	1791	3615	7263
13	1101	26	85	203	439	911	1855	3743	7519
14	1110	28	89	211	455	943	1919	3871	7775
15	1111	30	93	219	471	975	1983	3999	8031
Step Size		2	4	8	16	32	64	128	256

```

}

/*****
VLINN VST
EPROM2Linear()
Convert EPROM byte in companded format to linear voltage
Based on the AM6070 DAC Datasheet.
*****/
float AJLINNCLAPS::EPROM2Linear(unsigned short int x)
{
    //LINN LM-1 AM6070 u255 DAC Decode Table.
    static int dac_lut[128] =
    {
        0,2,4,6,8,10,12,14,16,18,20,22,24,26,28,30,
        33,37,41,45,49,53,57,61,65,69,73,77,81,86,89,93,
        99,107,115,123,131,139,147,155,163,171,179,187,195,203,211,219,
        231,247,263,279,295,311,327,343,359,375,391,407,423,439,455,471,
        495,527,559,591,623,655,687,719,751,783,815,847,879,911,943,975,
        1023,1087,1151,1215,1279,1343,1407,1471,1535,1599,1663,1727,1791,1855,1919,1983,
        2079,2207,2335,2463,2591,2719,2847,2975,3103,3231,3359,3487,3615,3743,3871,3999,
        4191,4447,4703,4959,5215,5471,5727,5983,6239,6495,6751,7007,7263,7519,7775,8031
    };
};
int sign, chord, sample;
float outputVolts;

```

The fact that the VLINN decodes the EPROM content in real time gives it the ability to import EPROM binary images as a replacement for certain stock voices, like you could do on a real LM-1.(See EPROM Loading.)

SAMPLE TUNING



This is one of the main exciting features of the Linn LM-1, unlike its successor the Linndrum, the LM-1 had a tuning knob per voice, for ALL the voices.

How the system works is not too hard to understand, a monolithic function generator chip **XR2206** was used as a **clock source** for EPROM content reading. The XR2206 output frequency will determine the frequency at which the EPROM content will be read (speed of the counter chip) hence the sample rate.

XR2206 Datasheet tell us that the frequency is determined by the external timing capacitor across pin 5 & 6 and the timing resistor. The LM-1 used R1 & R2 (a potentiometer) to set the value of the timing resistance. This configuration is the same for each voice.

Here you can see a part of an LM-1 schematics that shows how the XR2206 is connected and what values were used for the timing capacitor & timing resistor(s) for the Cabasa voice.

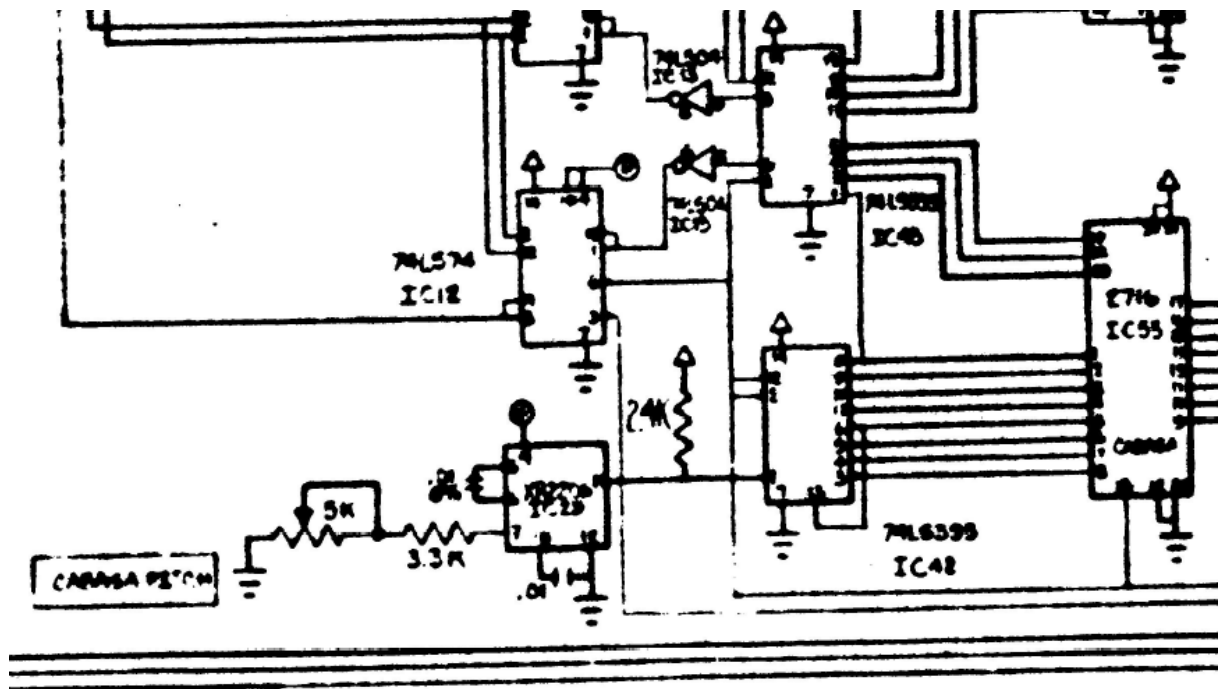

XR-2206

PRINCIPLES OF OPERATION

Description of Controls

Frequency of Operation:

The frequency of oscillation, f_o , is determined by the external timing capacitor, C, across Pin 5 and 6, and by the timing resistor, R, connected to either Pin 7 or 8. The frequency is given as:

$$f_o = \frac{1}{RC} \text{ Hz}$$

and can be adjusted by varying either R or C. The recommended values of R, for a given frequency range, as shown in Figure 5. Temperature stability is optimum for $4\text{k}\Omega < R < 200\text{k}\Omega$. Recommended values of C are from 1000pF to $100\mu\text{F}$.

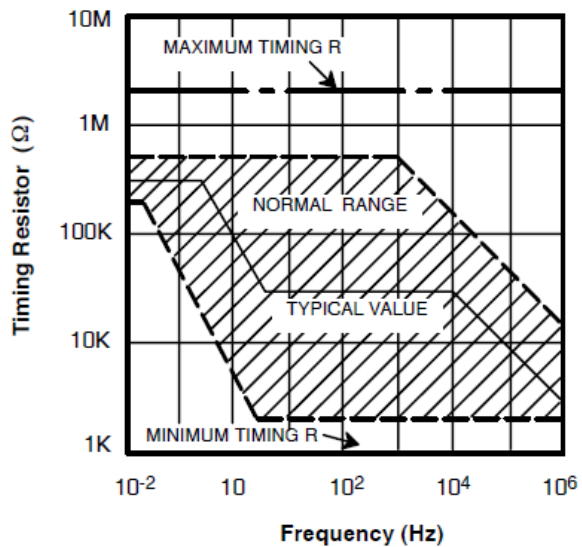

Following the datasheet we know that frequency is given as: $f_0 = 1/RC$ Hz

Basically on the LM-1 every voice was set like this:

Timing Capacitor **C = 0.01µf** (5%)

Timing Resistor **R = R1 + R2**

R1= 3.3K

R2= 0 to 5K (which is a 5K pot)

With this particular setting this gives us the following minimum and maximum sample rate for a voice on stock configuration:

MAX = $1/0.000033 = 30303$ Hz

MIN = $1/0.0000833 = 12005$ Hz

Quick modifications to increase the tune range were easy, for example: replacing the 5K pot by a 10K pot gives a lower minimum of 7512 Hz.

This table shows the values I used for the VLINN VST range. You can do the same on a real LM-1 simply by replacing potentiometers and resistors by the values in this table I made.

A	B	C	D	E	F	G	H	I
C Farad	R1 Ohms	R2 Ohms (POT)	FREQUENCY Hz	RC	R1 Kohms	R2 in Kohms (pot)		
0,00000001	3300	5000	12048,19277	0,000083	3,3 K	5 K	TYPICAL MIN	
0,00000001	3300	0	30303,0303	0,000033	3,3 K	0 K	TYPICAL MAX	
0,00000001	2200	100000	978,4735812	0,001022	2,2 K	100 K	MOD MIN	
0,00000001	2200	0	45454,54545	0,000022	2,2 K	0 K	MOD MAX	
0,00000001	2268	0	44091,71076	0,00002268	2,2K + 68 Ohms	0 K	VLINN MAX	
0,00000001	2268	100000	977,8229749	0,00102268	2,268 K	100 K	VLINN MIN	
XR2206 Function Generator settings for a Linn LM-1 Drum Computer Drum Board Voice.								

So you are able to set the tuning frequency from 978 Hz to 44092 Hz in VLINN VST, this has been set to 1000 Hz to 44100 Hz for convenience.

Note that a common usage in recording studios was to use the vary-speed on tape recorder machine to also change the pitch while recording or playing... Get yourself a good multi track K7 Recorder for cheap and experiment 😊

THE HIHAT CASE

The LM-1 Hihat circuitry was pretty unique!

Contrary to the other voices, the hihat prompts were read **constantly in a loop**, the closed or open triggered hihat then fires a VCA envelope that will be applied differently on the output.

For closed hihat the circuitry had the ability to discharge the current through an additional way based on the **decay potentiometer setting**. This basically makes the hihat sounding different on every hit and kind of gives it a live feel. The LM-1 seems to be the only drum machine of that time to do this clever trick that way, even the Linndrum doesn't had it.

This discharge following a classic natural Decibel like curve...

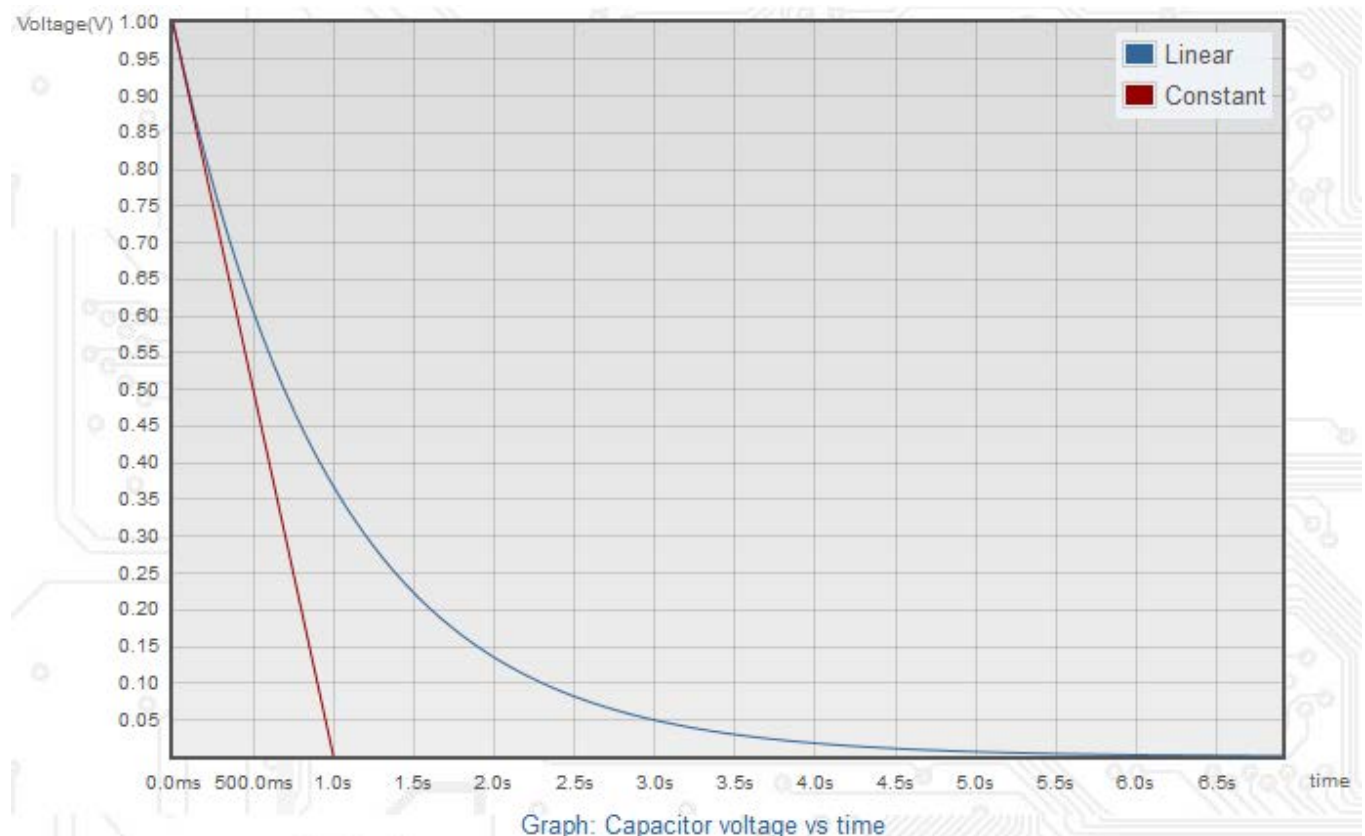

MAIN PANEL



Each voice has a volume level, simples as old vintage hardware. These sliders can be MIDI learned or automated as most of the VLINN parameters (See Automation.)

CEM FILTERS

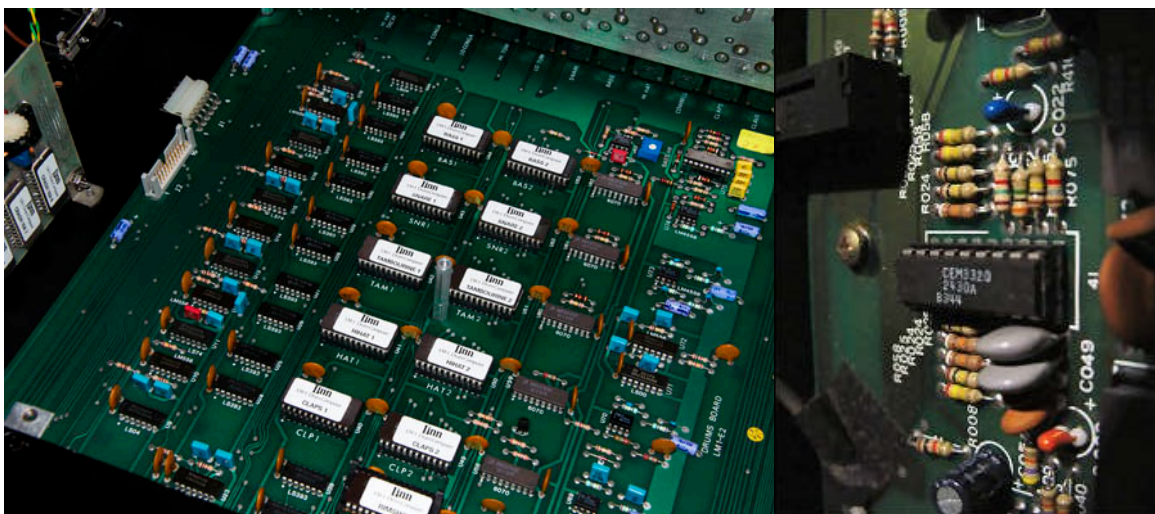

Quantized noise filtering:

Unlike the very first few produced LM-1 that were made without noise filters, later Revisions featured some **CEM3320 Voltage Controlled Filter** chips for the voices that needs a more bassy output.

The BASS, TOMS & CONGAS voices were filtered to minimize the remaining 8-bit quantized noise.

The 3320 can be configured in many ways to produce different type of filtering, in the LM-1 case, it was basically configured as a **4 Poles Low Pass Filter** with no resonance.

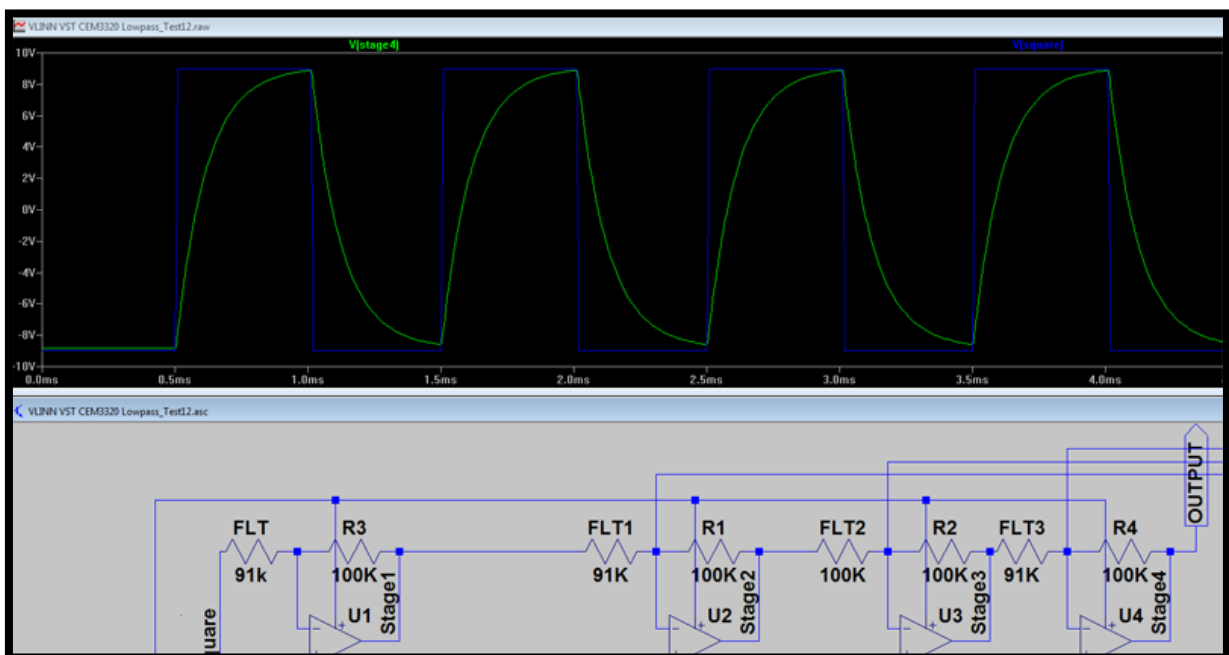

The CV which controls the frequency of the VCF was **shaped by the circuitry in a way that lets the transients pass through relatively unfiltered.**

The VLINN lets you fine tune the CV pulse or completely bypass the filter, this is useful when a voice is tuned very low or if you want to replace a "Bass" slot with another EPROM that doesn't require filtering. Try to experiment with or without depending of your needs.

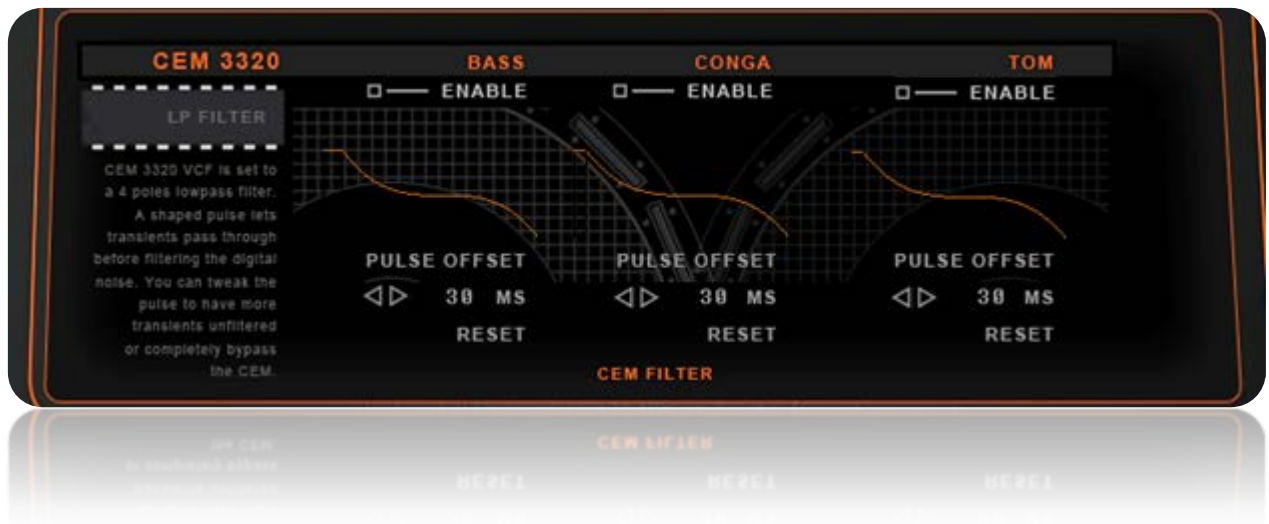

CEM Parameters:

- **ENABLE or BYPASS:** Select if the filter is activated or not for that particular voice.
- **PULSE OFFSET:** This setting in Milliseconds lets you fine tune the voltage pulse that controls the VCF frequency, the greater the offset the more transients will remain unfiltered, this ranges from 0–300 Ms. **RESET** sets it back to default. *(Default has been tuned to 30 Ms.)*

The graphic line represent the shape of the Control voltage, the lower the graphic point, the more it is filtered.

SETTINGS

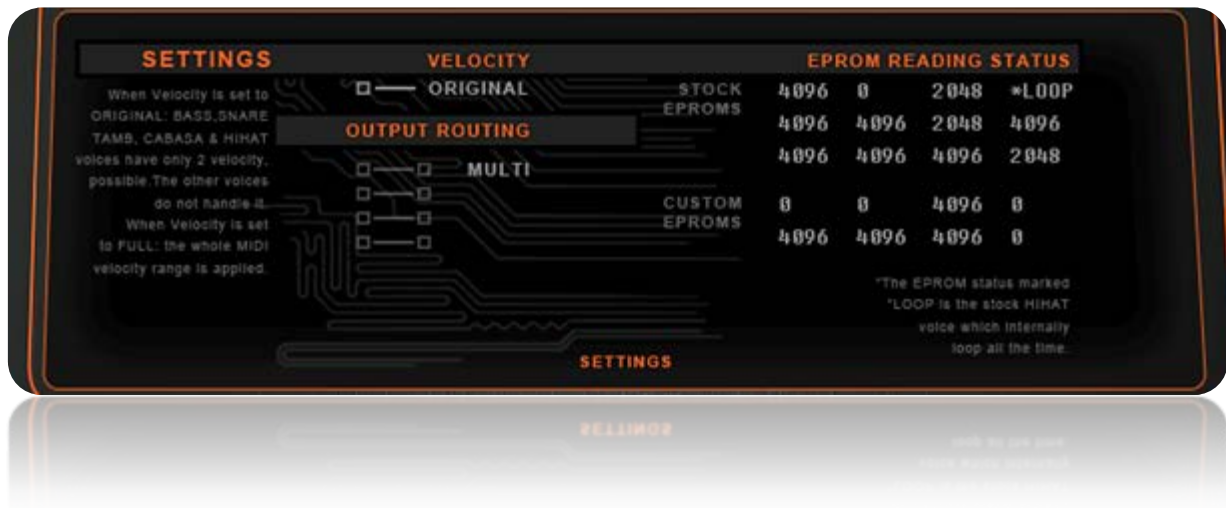

The Setting panel lets you choose how the velocity is applied and the output routing of the VLINN VST

Velocity

The Linn LM-1 as an early vintage unit did not featured a wide range of velocity storage; you had basically only 2 main levels, Loud or Quiet 😊

- **ORIGINAL:** This will convert any incoming MIDI trigger velocity to Max or Middle velocity depending on the incoming velocity, if above 64 it will be LOUD else is quiet.
- **FULL:** This will apply the full range of 127 MIDI velocity levels; however this features wasn't possible on a real LM-1 without heavy modifications. So why implement it in VLINN? Well usually you control the individual volumes of a recorded sequence while playing it back, this allowed live modification over the volume... you see the point? With full velocity applied it can saves you the levels automation task latter on if needed.

EPR0M Reading Status

You can see the EPROMS counters in real-time, this was originally a debug feature but I leave it there because it feels geeky, and it is nice to see those numbers move anyway 😊

Output Routing

The Linn LM-1 featured different outputs for all the voices and also main stereo out.

- **SINGLE:** This will route all the voices to the first stereo pair which is labeled as BASS (because it also serves as the BASS only output when set on MULTI.)
- **MULTI:** This will route all the voices to a separate output labeled with the voice name. You have to enable the multiple outputs in your DAW. Each DAW has its way of doing it but it is generally straight forward. The multiple outputs let you MIX easily the VLINN voices in your DAW as you will have a plain channel strip for each one.

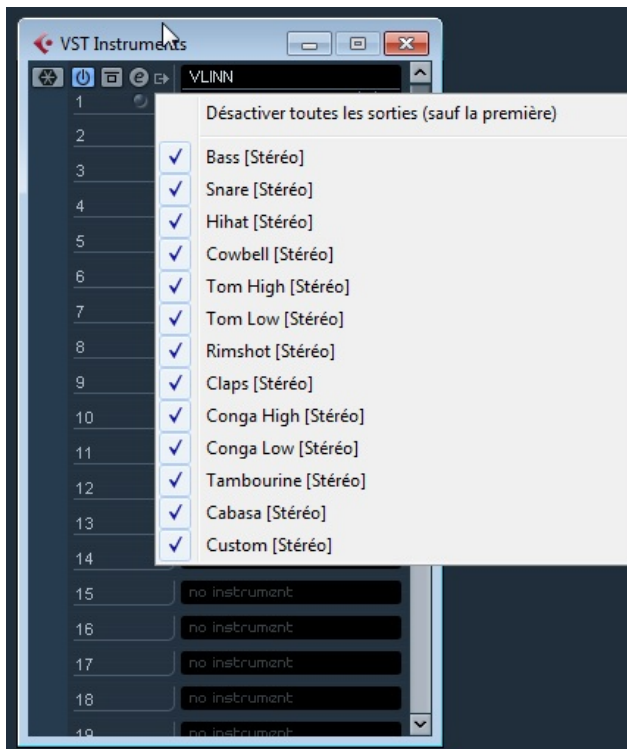

Here an example in Cubase

EPROM LOADING

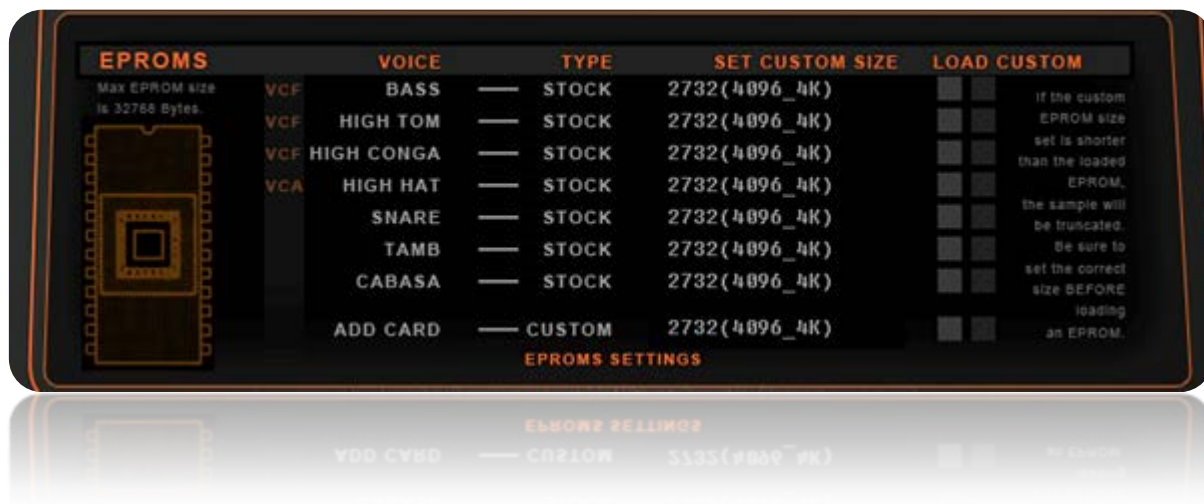

Stock EPROMS

The STOCK setting uses the original LM-1 EPROMS including the Rim Shot that wasn't there on the very first few LM-1.

There were differences between LM-1 models, I have noticed that the stock Kick Drum might be different on certain model; the Linndrum Kick seems to be often used as a replacement through the years... The stock LM-1 sounds are written in the ears of those who have experienced the 80s funk vibe, as were the Linndrum ones, but the LM-1 is definitely the fattest.

Custom EPROMS

The VLINN features an import function for compatible EPROM Binary Images (.bin files)

This kind of works in a vintage way...Mainly because **HEY! IT'S A VINTAGE GEAR EMULATION DUDE!**

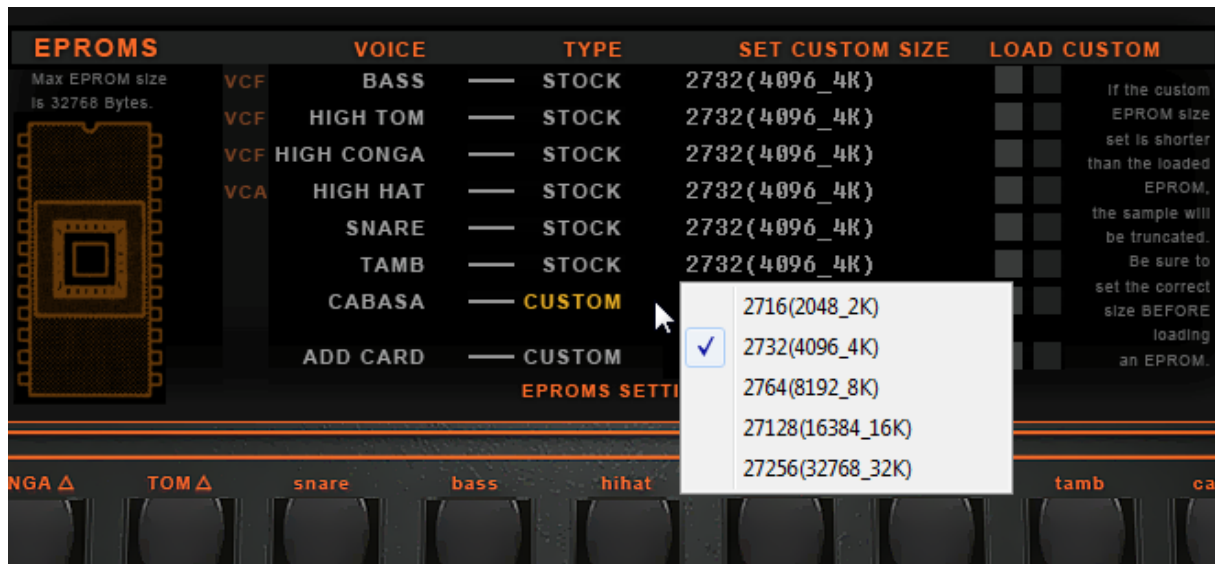

- **FIRST** you need to set the custom size of the EPROM image you plan to load, don't do it after because changing the size of a custom slot will erase the memory of the PROM to ensure the next loaded data will not be corrupted.
- Note that the EPROM sizes available correspond to typical format you might find and most of the samples you will load will fit in.

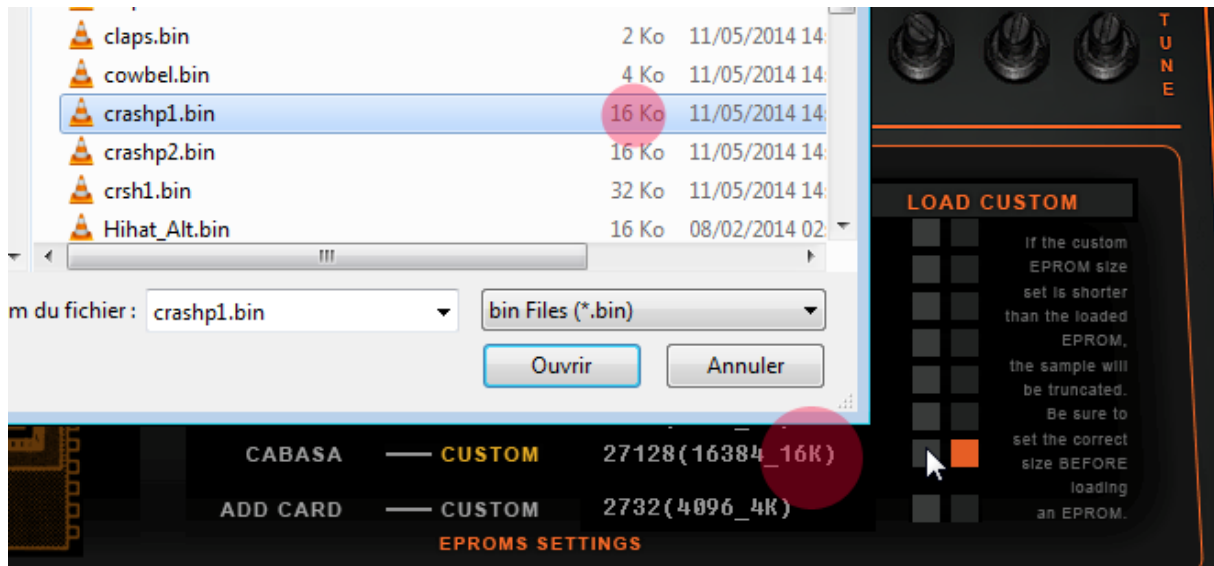

- Once the size is specified you can **LOAD an EPROM image of the corresponding size by clicking in the first square button**. If you make a mistake it will not blows up 😊 simply if you try to load a bigger file than the size previously set you will lack the ending part of the sample... if you do the opposite, loading a shorter file than the previously set size you can have corrupted data instead of silence in certain cases.
- **The STOCK / CUSTOM switch** can be changed at any time, this means you can change between STOCK and the CUSTOM loaded EPROM on the fly, however depending on the EPROM loaded content you can experienced a short buffer squeak that will disappear on the next trigger. It is safer to change between STOCK and CUSTOM when not playing but it doesn't mean you cannot do it 😊. **Also note that the ADD CARD voice is an additional voice that is always set to CUSTOM, which means that it does not contain data unless you load some in.**
- Not all the voices can be replaced but 7 of them can, the ones marked VCF will benefit from the CEM filtering, replacing the HIHAT will pass through the VCA and the Decay will work on it, the looping capability of the STOCK HIHAT is unique for the STOCK HIHAT, so the CUSTOM loaded DATA will not loop.

Paul J Whites, owner of ELECTRONGATE.COM did a great work in finding and hosting a huge archive library of compatible EPROM images in companded format that you can load in VLINN VST, Linndrum, DMX etc...

Some EPROM images are provided in parts and need to be assembled to a bigger EPROM image. You can do that easily with the PROMENADE software provided and hosted on the same website. **It also lets you convert your own .wav prepared samples to compatible .bin images.**

Yeah, you can also load your own personal custom made samples into the VLINN, and it will pass through the circuitry.

It is a good way to experiment as you can load anything in there... just make sure you prepare your samples correctly, normalize the peaks and put a nice fade out in the end so the sample does not cut short, this could also produce buffer squeak in some cases.

Try to record your sample at 22050 Hz so as you can have a nice range of tuning.

PRESETS IMPORT / EXPORT



FXP & FXB

VLINN can load and import its own format presets & banks. All Custom EPROMS file paths are also saved with the patch.

All MIDI LEARNED & ASSIGNED parameters will also be saved with the patch.

Simply name the preset and right click the **PROGRAM MENU** to save either 1 preset or the whole bank, you can also copy the current patch to another location.

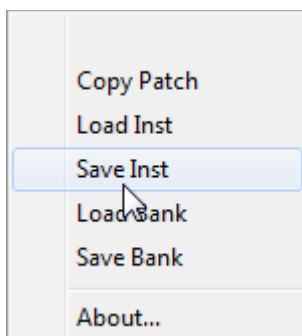

MIDI AUTOMATION

MIDI LEARN

Almost all of the VLIINN parameters can be **automated via midi learn** or **DAW automation** allowing great control over the sound.

Simply right click on a button, knob or slider to assign external MIDI Control or use DAW automation.

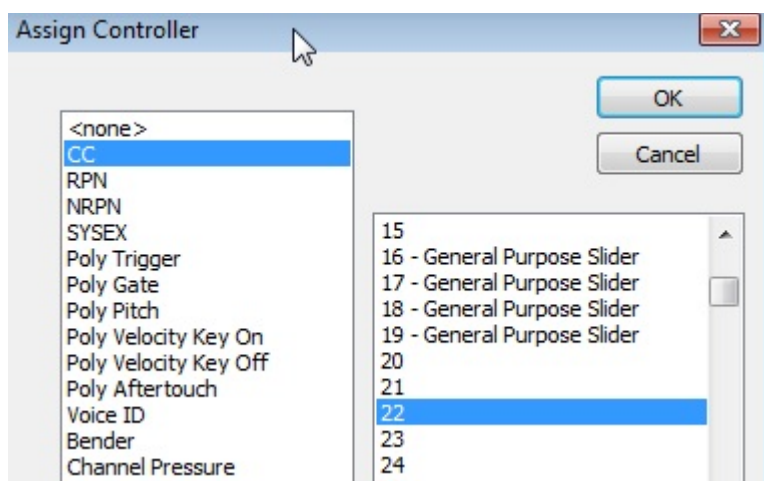

Almost all type of MIDI message can be assigned or MIDI learned.

LM-1 SEQUENCER

Behind the myth...

Lots of things have been told about vintage drum machine distinct groove...Always being compared with modern counterpart, resulting in differences between 2 same sequences...

Why? Here is the start of an answer: the sequencer resolution.

A resolution is usually marked as a **PPQN** value which stands for **Pulse per Quarter Note**.

The number before the PPQN or often written PPQ is simply the maximum number of places available to store a recording note inside the time lapse of a 1/4 note at a given tempo.

Modern sequencers just as your DAW usually have a 960 PPQ or higher which is more than enough to capture the data accurately. But what happens when you use a swing value and quantize? Yeah some notes will be shifted by x % amount and they will be stored in one of the possible place according to the PPQ resolution.

Vintage Drum Machine such as the Linn LM-1 had a 48 PPQ sequencer, which is smaller than modern sequencers but still enough to provide some good timing. Roger Linn introduced the shuffle function better known as today's swing offering **50, 54, 58, 62, 66, and 70% swing**. Why these values?

Because this is what permits a 48 PPQ resolution.

If you don't quantize on the LM-1 (set to HI) things are still recorded at 1/192 which is 48 PPQ. The CPU used a clock signal to determine the length of a 1/192 note.

If you use auto correct you have these quantize values available:

- 1/8
- 1/8T
- 1/16
- 1/16T
- 1/32
- 1/32T

Look at this table and notice why Roger Linn sticks to those values of swing on the LM-1.

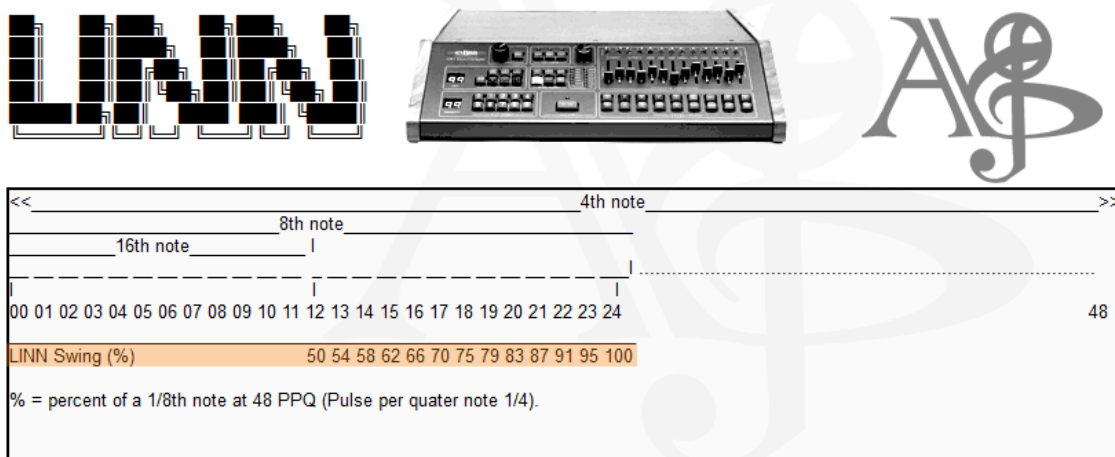

Ok so what is the difference?

Look at this, this is the same thing recorded at 960 and at 48 PPQN.

You will notice that the final placement is not the same! This is because as the resolution is limited, possible places for a note also are.

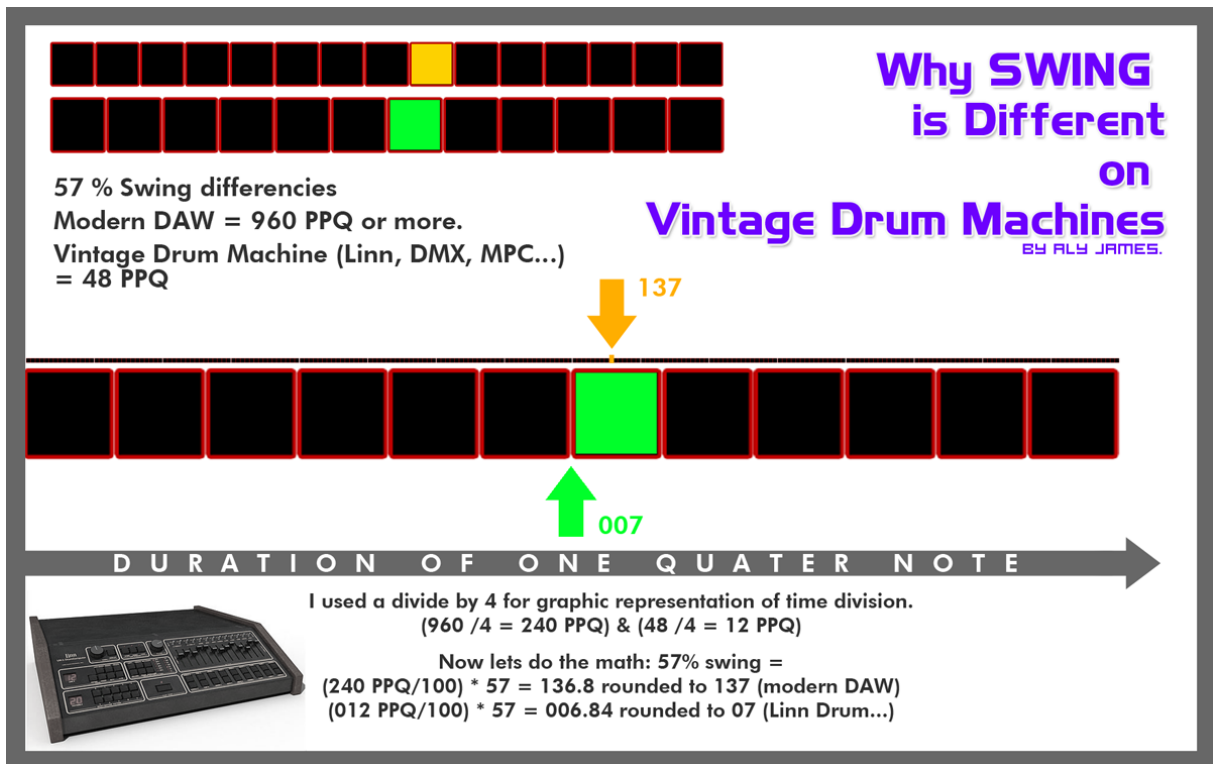

So basically, the groove is different because of the 48 PPQN and the good news is;

You can do the same easily in your modern DAW.

When you have created a sequence you like, export it as a MIDI file but specify the resolution to **48 PPQN** (most DAW can do this). **Import it back and compare to the original**, this does not means it will sound better or worse but a little different, apparently people seems to prefers 48 PPQN, hence more quantized things...

Of course if you try this on a straight 1/16 quantized beat, nothing should change 😊

This is the main reason I did not felt the need to emulate the LM-1 sequencer in VLINN VST.

You can sample an LM-1 but it will not feel or have the timing like the LM-1 or VLINN playing the beat because the samples had a bit of dead air on the front and this is changing based on the sample pitch!

HIDDEN SECRETS

LM-1 Experiments

In the studio sometimes the LM-1 was processed through guitar pedals and other gears like eventide harmonizer, AMS RMX16 reverb with nonlin2 and reverse presets.

You can have good results with Pultec or API Equalizers.

Some artists used a lot the variable pitch available on tape recorders to make effects or drastically change the pitch of the final recording.

I don't know exactly why but the simplicity of the LM-1 scream for experimentation so have fun with it and try things.

What modern DAWS offer in term of automation is a real improvement because in the good old days, you have to make pitch automation for the LM-1 samples manually. 😊

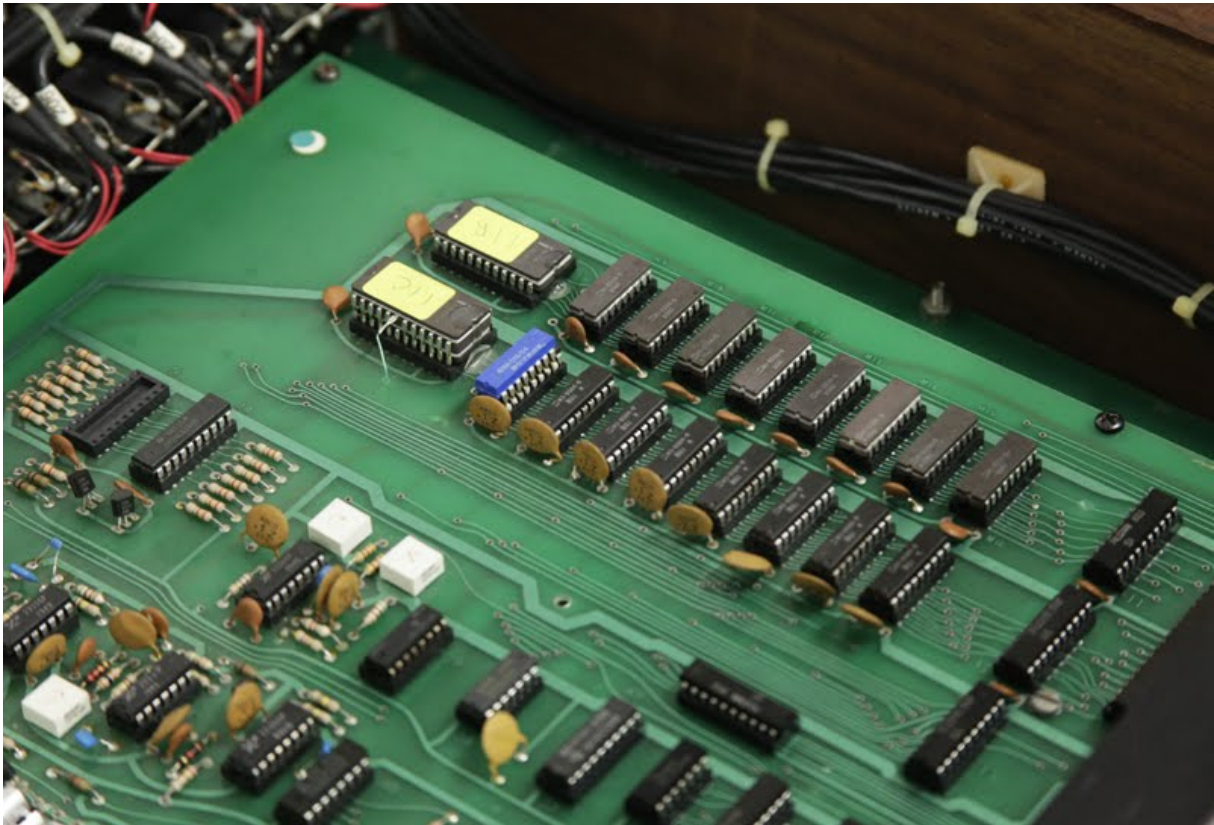

LINKS

Aly James centric links

Official Website www.alyjameslab.com

Dev Blog www.alyjameslab.blogspot.com

Facebook News www.facebook.com/alyjamesound

Youtube Channel www.youtube.com/alyjamesproduction

Soundcloud demos <http://www.soundcloud.com/alyjameslab>

Twitter @alyjamestwitt

CONTACT alyjames.info@gmail.com

External links

Roger Linn Website <http://www.rogerlinndesign.com/>

ELECTRONGATE Archive <http://www.electrongate.com/dmxfiles/downloads.html>

PROMENADE Software <http://www.electrongate.com/dmxfiles/promenade/index.html>

HOPE YOU HAVE FUN WITH THE VLINN!



DISCLAIMER & LICENCE AGREEMENT

DISCLAIMER

VLINN (the software) is provided as-is, without warranty of any kind. Aly James Lab (alyjames.info@gmail.com, the Author) disclaim all warranties relating to the Software, whether express or implied, including but not limited to any implied warranties of merchantability and fitness for a particular purpose, and all such warranties are expressly and specifically disclaimed. The Author shall not be liable for any indirect, consequential or incidental damages arising out of the use or inability to use the Software even if the Author has been advised of the possibility of such damages or claims. The user of the Software bears all risk as to the quality and performance of the Software. If your computer blows up, I say "I wasn't there!" of course that should not happen... 😊

LICENCE AGREEMENT

VLINN is copyright © 2014-2015 Aly James.

VLINN (the software) is not public domain, and is protected by the copyright laws of the international community. In using VLINN, you are not obtaining title to VLINN or any copyrights. You may not sublicense, rent, lease, convey, distribute copy, modify, translate, convert to another programming language, decompile, or disassemble the Software for any purpose. You may only redistribute the Software for promotion purpose with Aly James prior written permission. Where redistribution is authorized in writing by the Author, VLINN must be redistributed in its original archive format, and must not be modified in any way. All such authorized redistribution must be accompanied by clear messages stating the origin of the software as an Aly James Lab product, this license, a link to the Website alyjameslab.com. The user ID is hard coded into the GUI and each version of the software is unique. By Using the Software, you are agreeing to this disclaimer and license.

VST is a trademark of Steinberg Media Technologies GmbH.

VLINN VST does not emulate the LM-1 Drum Computer Sequencer & OS. It does not in any way imply Roger Linn's permission or endorsement of the VLINN product.

However I have a kind permission from Roger Linn to use the LM-1 original samples binaries in VLINN for convenience. Secondly the use of the Linn name and logo type font is use strictly here for the legitimate purpose of comparison and tribute to this great machine.

©2014-2015 ALYJAMESLAB